

LMP Keyboard ProtectCase for iPad 10.2"

Quick Start Guide

EN

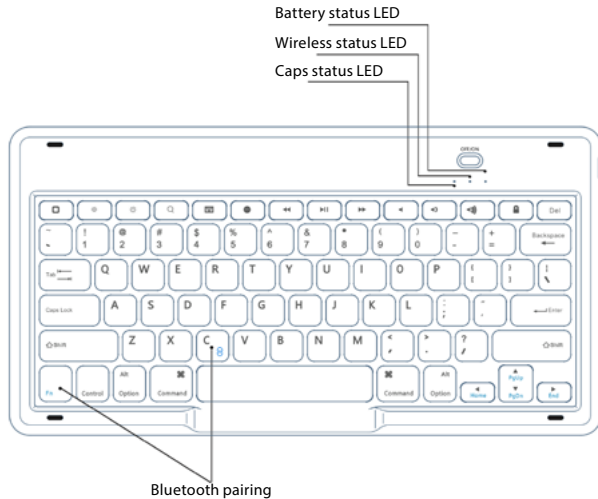

Multifunctional Keys

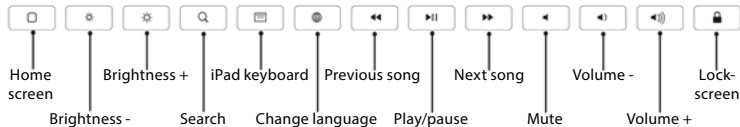

LED Status Indicators

Caps Lock indicator	Light on means uppercase letters; light off means lowercase letters
Wireless status	Press „Fn+C“ to perform the pairing between iPad and keyboard. The LED will turn off when the connection to the iPad has been successfully established.
Battery status	A flashing light indicates a low battery level. Constant red light when charging. Red LED will go off when fully charged.

Keyboard Pairing

- 1) Switch on the iPad, then pair the Bluetooth keyboard.
- 2) Move the on/off switch to the ON position, then press „Fn+C“ to perform the pairing. The LED will turn off when the connection to the iPad has been successfully established. If the connection has not been established within 3 minutes you need to repeat the pairing process from the start.
- 3) Select „Settings“ – „Bluetooth“.
- 4) Select under „OTHER DEVICES“ the „LMP BT Keyboard“.
- 5) A 4-digit numeric code is displayed on the screen. Type in the numbers on the keyboard and press „Enter“ on the keyboard to confirm.
- 6) The pairing has been successful when „LMP BT Keyboard“ is listed under „MY DEVICES“ in the Bluetooth settings.
- 7) In case the pairing has failed, repeat the pairing process from 2.

Connection Problems

- 1) Make sure the keyboard is turned on and the battery is charged.
- 2) Make sure the keyboard is close to the iPad.
- 3) Make sure that Bluetooth is enabled on the iPad.
- 4) Make sure the keyboard has been paired with the iPad.

Maintenance

- 1) Keep the keyboard away from liquids and magnetic fields.
- 2) Use a soft cloth to clean the keyboard.
- 3) When not in use, switch off the keyboard.

Mounting the Stand



1) Pull the magnetic flap backwards. Push the center of the stand outwards.

2) Put the magnetic flap over the stand holder.

3) The stand is now firmly locked.

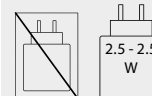

The keyboard requires a charging power of 2.5W to ensure proper charging. USB Power Delivery is not supported.

LMP Keyboard ProtectCase für iPad 10.2"

Bedienungsanleitung

DE

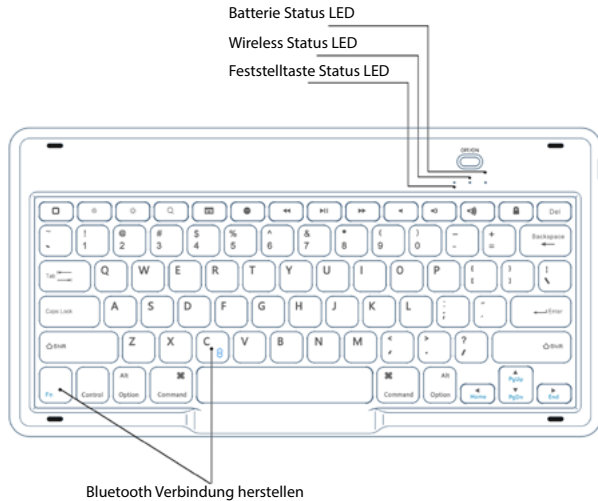

Multifunktions Tasten

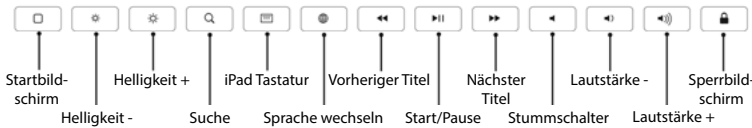

LED Status Anzeige

Feststelltaste	Licht an bedeutet Grossbuchstaben, Licht aus bedeutet Kleinbuchstaben.
Wireless	Drücken Sie „Fn+C“, um die Kopplung zwischen iPad und Tastatur herzustellen. Die LED schaltet aus, sobald die Verbindung zum iPad erfolgreich etabliert wurde.
Ladestand Batterie	Ein blinkendes Licht zeigt niedrigen Batteriestand. Konstantes rotes Licht während des Ladens. Bei vollständiger Ladung erlischt rotes Licht.



Tastatur koppeln

- 1) Zuerst das iPad in Betrieb nehmen, danach die Tastatur koppeln.
- 2) Ein/ Aus-Schalter in die rechte Position, dann "Fn+C" drücken, um die Kopplung herzustellen. Die LED "Wireless Status" blinkt anschliessend. Achtung: Wenn nach Ablauf von 3 Minuten keine Verbindung hergestellt werden konnte, muss der Vorgang erneut ausgeführt werden!
- 3) Wählen Sie "Einstellungen" – "Bluetooth". Stellen Sie sicher, dass Bluetooth eingeschaltet ist.
- 4) Wählen Sie unter "ANDERE GERÄTE" das "LMP BT Keyboard" aus.
- 5) Ein 4-stelliger Zahlencode wird auf dem Bildschirm angezeigt. Tippen Sie die Zahlen ein und bestätigen Sie den Code mit der "Enter"-Taste auf der Tastatur.
- 6) Die Kopplung ist erfolgreich, sobald unter "MEINE GERÄTE" das "LMP BT Keyboard" als "Verbunden" angezeigt wird.

Vorgehen bei Verbindungsproblemen

- 1) Stellen Sie sicher, dass die Tastatur eingeschaltet und Batterie aufgeladen ist.
- 2) Stellen Sie sicher, dass die Tastatur in der Nähe des iPad ist.
- 3) Stellen Sie sicher, dass Bluetooth in den iPad-Einstellungen aktiviert ist.
- 4) Stellen Sie sicher, dass die Tastatur mit dem iPad gekoppelt wurde.

Wartung und Warnhinweise

- 1) Halten Sie die Tastatur von Flüssigkeiten und Magnetfeldern fern.
- 2) Benutzen Sie ein weiches Tuch für die Reinigung der Tastatur.
- 3) Schalten Sie die Tastatur aus wenn Sie sie nicht benutzen.

Aufstellen der Halterung



- 1) Ziehen Sie die Magnetklappe nach hinten. Drücken Sie die Mitte der Halterung nach aussen.



- 2) Legen Sie die Magnetklappe über die Halterung.



- 3) Die Halterung ist nun fest verriegelt.

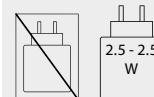

Die Tastatur benötigt eine Ladeleistung von 2.5W, um einen ordnungsgemässen Ladevorgang zu gewährleisten. USB Power Delivery wird nicht unterstützt.

LMP Keyboard ProtectCase per iPad 10.2"

Manuale

IT

LED Status carica della batteia

Wireless Status LED

Tappi LED di stato

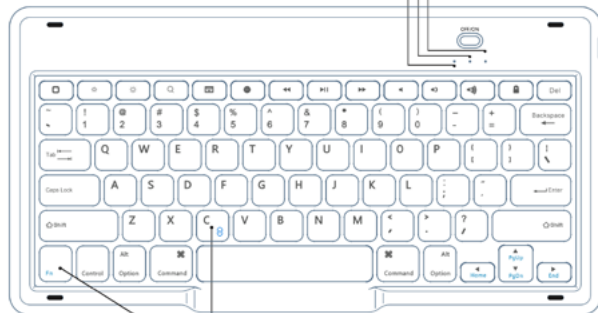

Collegamento Bluetooth

Multifunctional Keys

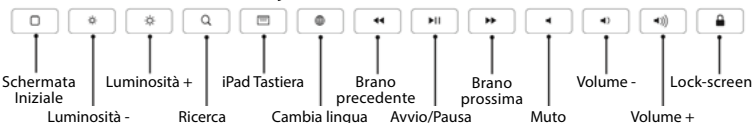

Schermata Iniziale Luminosità + iPad Tastiera Brano precedente Brano prossima Volume - Lock-screen
Luminosità - Ricerca Cambia lingua Avvio/Pausa Muto Volume +

Indicatore di stato a LED

Stato del Tasto Caps Lock	Con indicatore LED spento, maiuscolo attivato; con indicatore LED spento: minuscolo attivato.
Stato del Wireless	Premere „Fn+C” per eseguire l'accoppiamento tra iPad e keyboard. Il LED si spegne quando la connessione all'iPad è stata stabilita con successo.
Stato della Batteria	Una luce lampeggiante indica un livello basso della batteria. Luce rossa costante durante la carica. La luce rossa si spegne quando è completamente carica.



Aggancio Keyboard

- 1) Impostare prima l'iPad, poi accoppiare la tastiera
- 2) Ruotare l'interruttore on/off sulla posizione destra, quindi premere "Fn+C" per eseguire l'accoppiamento. Il LED si spegne quando la connessione con l'iPad è stata stabilita con successo.
- 3) Selezionare "Impostazioni" – "Bluetooth". Assicurarsi che il Bluetooth sia attivato.
- 4) Selezionare in "ALTRI DISPOSITIVI" la "LMP BT Keyboard".
- 5) Sullo schermo viene visualizzato un codice numerico a 4 cifre. Digitare i numeri e confermare il codice con il tasto "Enter" sulla tastiera.
- 6) L'accoppiamento ha successo non appena la tastiera "LMP BT Keyboard" viene visualizzata come "Connected" sotto "MY DEVICES".

Procedura per i problemi di Connessione

- 1) Assicurarsi che la tastiera sia accesa e che la batteria sia carica.
- 2) Assicurarsi che la tastiera sia vicina all'iPad.
- 3) Assicurarsi che il Bluetooth sia abilitato nelle impostazioni dell'iPad.
- 4) Assicurarsi che la tastiera sia accoppiata all'iPad.

Manutenzione e Avvertenze

- 1) Tenere la tastiera lontana da liquidi e campi magnetici.
- 2) Utilizzare un panno morbido per pulire la tastiera.
- 3) Spegner la tastiera quando non la si utilizza.

Impostazione dello Stand



1) Tirare il lembo magnetico all'indietro. Spingere il centro del supporto verso l'esterno.



2) Mettere il lembo magnetico sopra il supporto del supporto.



3) Il supporto è ora saldamente bloccato.



La tastiera richiede una potenza di ricarica di 2.5 W per garantire una ricarica corretta. USB Power Delivery non è supportato.

LMP Keyboard ProtectCase for iPad 10.2"

Guia Início Rápido

PT

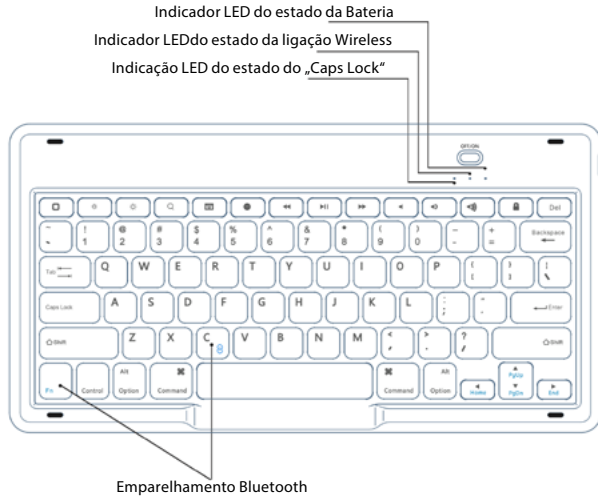

Teclas multifuncionais

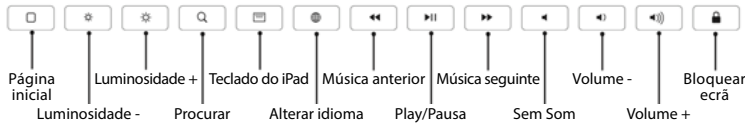

Significado Luzes Led

Caps Lock	Quando ligado significa letras maiúsculas, quando desligado significa letras minúsculas.
Wireless	Carregue „Fn+C“ para fazer o emparelhamento entre o iPad e o teclado. A luz irá desligar quando a conexão com o iPad tiver sido realizada com sucesso.
Bateria	Uma luz a piscar indica bateria em baixo. Luz vermelha constante indica que está a carregar. A luz vermelha desliga-se quando o teclado está completamente carregado.

Emparelhar o teclado



- 1) Ligar o iPad e conectar ao Bluetooth do teclado.
- 2) Mover o botão ON/OFF para a posição ON e pressionar „Fn+C“ para emparelhar. A luz LED irá desligar quando o emparelhamento for efetuado com sucesso. Se a conexão não for estabelecida dentro de 3 minutos, deverá recomear todo o processo de emparelhamento.
- 3) Seleccione “Definições” – “Bluetooth”. Certifique-se que o Bluetooth está ligado.
- 4) Seleccione no menu “Outros dispositivos” a opção “LMP BT Keyboard”.
- 5) Um código com 4 algarismos irá aparecer no ecrã. Escreva os números no teclado e carregue em “Enter” para confirmar.
- 6) O processo de emparelhamento estará completo com sucesso quando “LMP BT Keyboard” aparecer na lista de “Os meus dispositivos” nas definições de Bluetooth.
- 7) No caso do emparelhamento falhar, inicie o processo a partir do ponto 2)

Connection Problems

- 1) Certifique-se que o teclado está ligado e carregado.
- 2) Certifique-se que o teclado está perto do iPad.
- 3) Certifique-se que o Bluetooth do iPad está ligado.
- 4) Certifique-se que o teclado está emparelhado com o iPad.

Maintenance

- 1) Mantenha o teclado afastado de líquidos e campos magnéticos.
- 2) Use um pano suave para limpar o teclado.
- 3) Desligue o teclado, quando não estiver a utilizar.

Mounting the Stand



1) Puxe a aba magnética para trás. Empurre o centro do stand para fora.



2) Coloque a aba magnética no suporte do stand.



3) O stand está agora pronto e bloqueado.

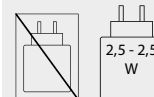

O teclado requer uma potência de carregamento de 2,5 W para garantir um carregamento adequado. O USB Power Delivery não é suportado.