

# Quick Installation Guide

## Unit Views

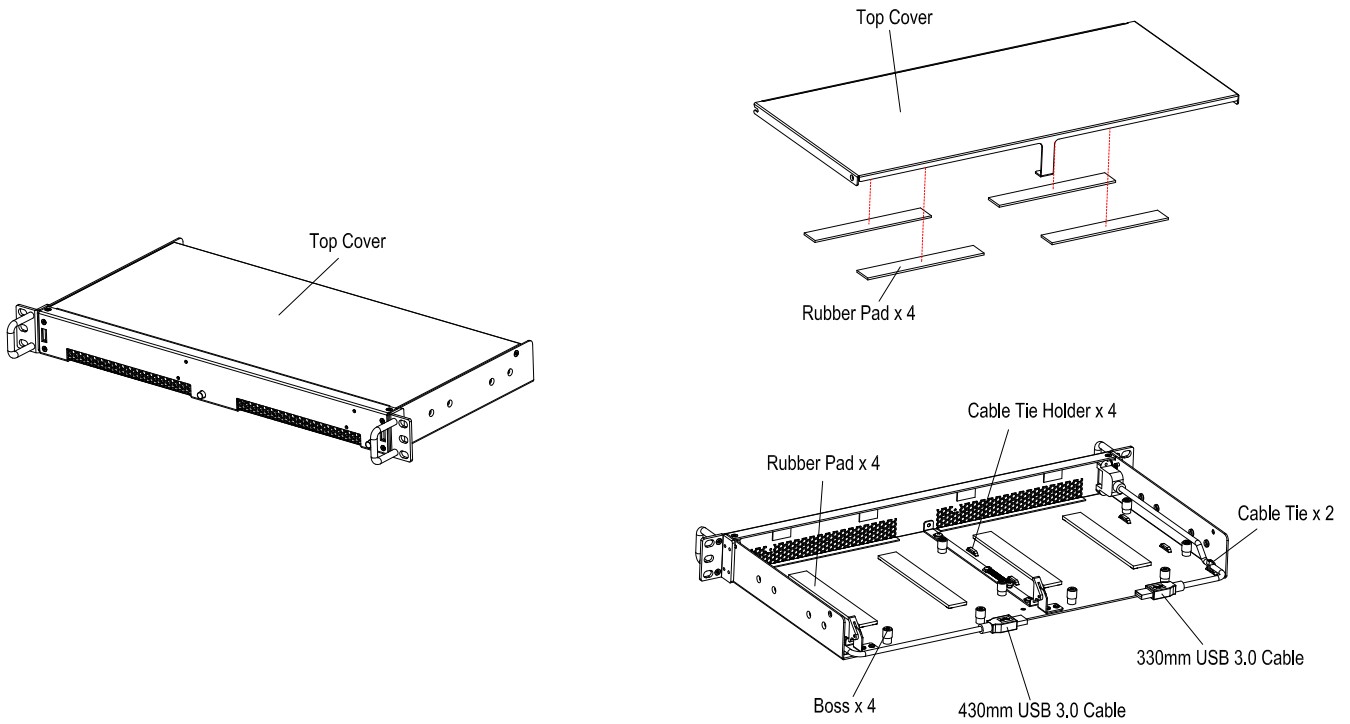

## Mac mini Installation

### (A) Remove Top Cover

(1) Remove the three (3) screws.

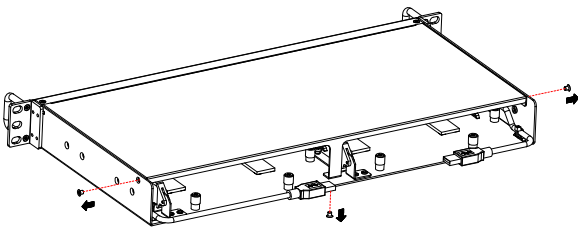

(2) Lift up the top cover and slide it out.

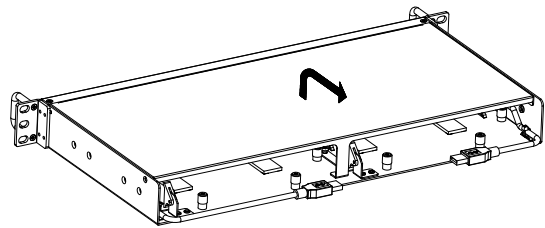

(3) Remove the top cover.

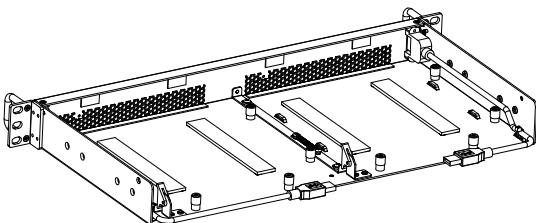

## (B) Install Mac mini

(1) Release four (4) bosses.

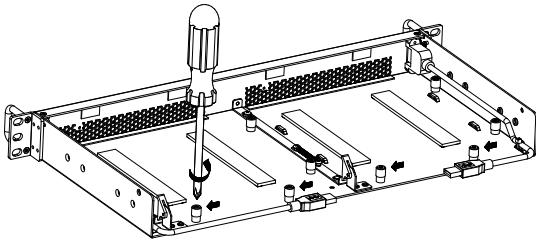

(2) Incline the Mac mini and push back the plastic hook. Insert the Mac mini so the plastic hook is positioned to the on/off button.

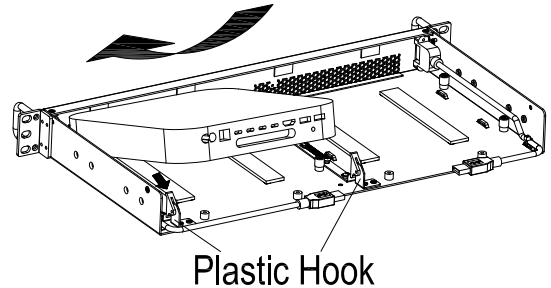

(3) The Mac mini must be inside the anti-vibration posts.

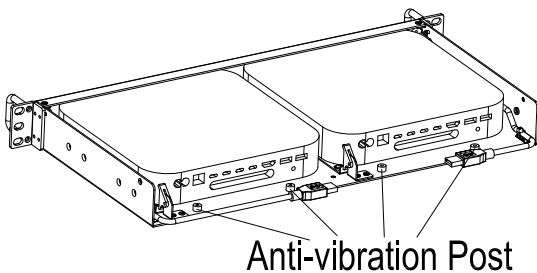

(4) Insert the four (4) bosses to hold the Mac mini in place.

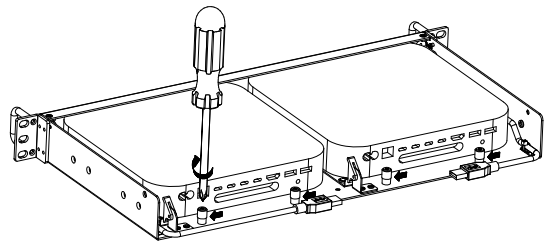

(5) Insert the USB plug into the USB port of the Mac mini (to access it from the front's USB port).

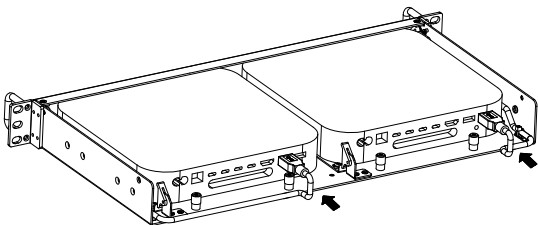

(6) Install the top cover by fitting the cover and attaching the three (3) screws.

